



Ultima Fiber Optic Install Kit

Fiber Optic Upgrade Installation Kit Instructions
Ultima Series 500 Models

www.UltimaDentalSystems.com

UDS Technical Support Team: (954) 772-9779



Fiber Optic Install Kit Instructions For U500 Models

1. Un-pack your fiber optic kit
2. Un-screw the single black screw located on the left side of the front panel to gain access to the inside of the panel. The front panel will swing open on its hinge like a door.



Fiber Optic Install Kit Instructions For U500 Models

3. Remove the sticker on the bottom of the fiber optic time delay module and mount it on back of the panel between the distribution block and water relay. Make sure the surface area is clean, otherwise the module will stick to the surface of the back panel.

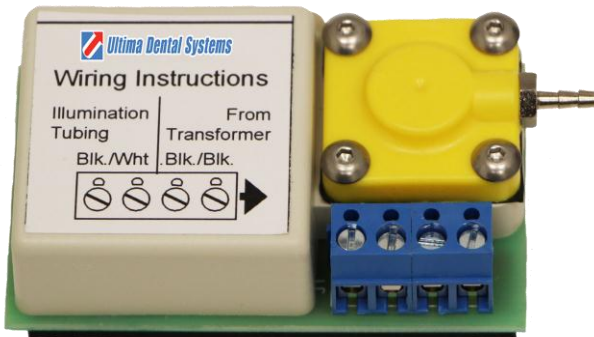

Fiber optic time delay module

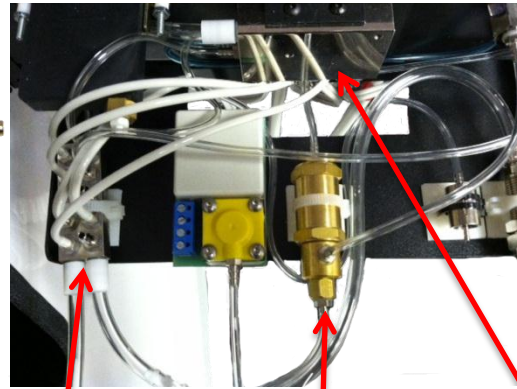

Distribution
Block

Water Relay

Control Block

4. Remove the old hand piece tubing from the bottom of the control block.

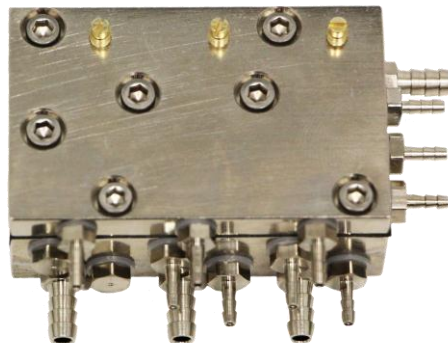

Control Block

Fiber Optic Install Kit Instructions For U500 Models

5. Attach the new fiber optic hand piece tubing provided in the kit to the control block. The new Fiber optic tubing should be attached to the portion of the control block for the blue color coded line (A blue dot may be found on the hand piece holder for the highspeed drill).
6. The new hand piece tubing is already split and cut to the exact length for your convenience. The tubing is split into three parts: Two small thin pieces of tubing and one large piece.

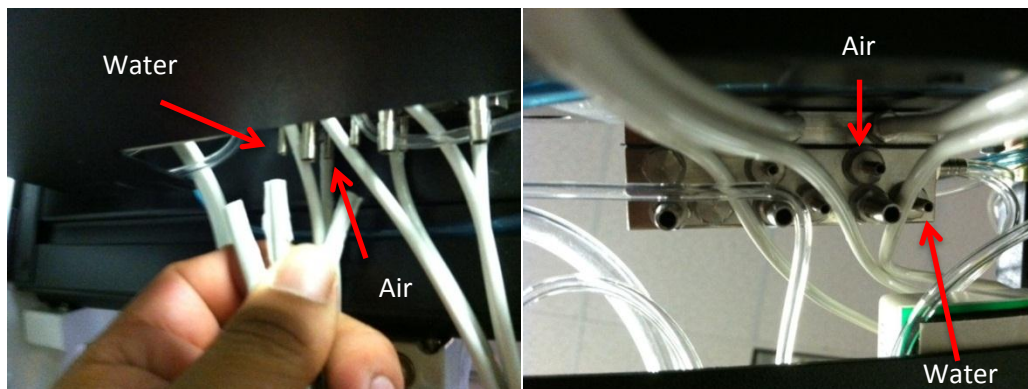

The small metal barb closest to the front panel is the air line

7. Holding the tubing towards you with the large piece on the bottom connect the tubing to the control block as follows: **Big tubing = Main air drive, Small Tubing (on left) = Water, Small Tubing (on right) = Air.** * Once the tubing is connected, if you get air blowing from the high speed drill, but no water, and all of the water control knobs and toggles are on then the two smaller pieces of tubing are on backwards.*

Fiber Optic Install Kit Instructions For U500 Models

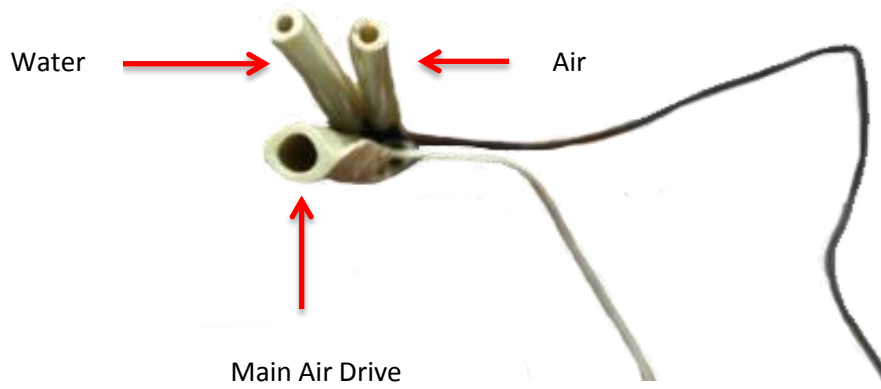

- Connect the thin clear 4" tubing provided with the kit from the time delay module to the white plastic Tee on the fiber optic hand piece tubing. ****The air drive on the fiber optic delay module is the metal barb sticking out of the front, located on the yellow portion of the delay module****

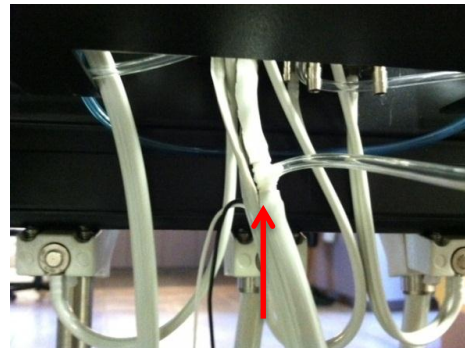

- Connect the fiber optic power adapter to the 6 outlet power strip inside your unit and neatly run the power cord to the front panel.
- Connect the remaining wires to the fiber optic delay module.



Ultima Dental Systems

Fiber Optic Install Kit Instructions For U500 Models

The wire pattern diagram is as follows:

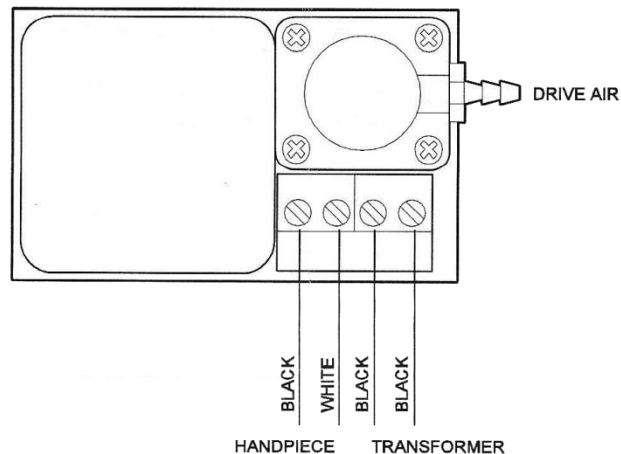
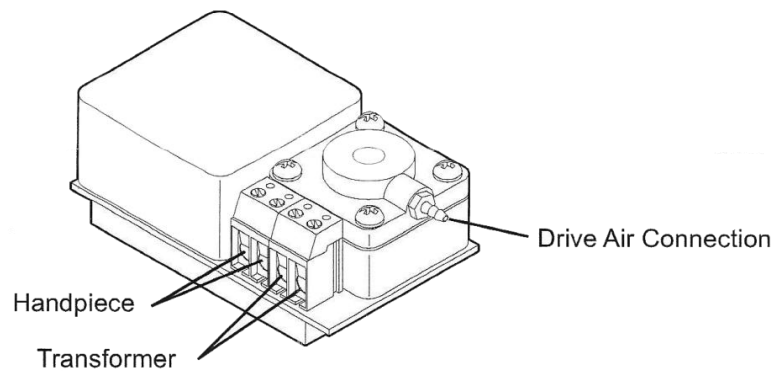

11. Once all of the wires are securely fasten, close the front panel and re-place the single black screw to secure the panel shut.

Should you require any assistance simply call the **UDS Technical Support Team**: (954) 772-9779 or Email us at UDS.FLA@Gmail.com